

Site Plan

A charming world,
on the inside.



Legend

- | | |
|------------------------------------------------|---------------------------|
| 1 Side Gate | 15 AI Fresco Dining Deck |
| 2 Main Entrance
Water Feature | 16 Picnic Lawn |
| 3 Guardhouse | 17 Play Lawn |
| 4 Arrival Court | 18 Lounge Terrace |
| 5 Sun Deck | 19 Entertainment Pavilion |
| 6 Indoor Gym | 20 Kid's Play Zone |
| 7 Male And Female Toilets
And Changing Room | 21 Kid's Play Wall |
| 8 Lap Pool | 22 Sunken BBQ Pavilion |
| 9 Entrance Court | 23 Jungle Jacuzzi |
| 10 Jacuzzi Pool | 24 Jacuzzi Deck |
| 11 Shallow Pool Sundeck | 25 Hammock Island |
| 12 Kid's Water Jet Pool | 26 Tranquil Hideaway |
| 13 Pool Shower | 27 Meditation Deck |
| 14 Reflective Courtyard | 28 Secret Garden Walk |
| | 29 Golfer's Green |



Penthouse

Type PH1
 244 sqm / 2,626 sqft
 Blk 39 #05-01
 (Mirrored)
 Blk 43 #05-12

The best party venue under the stars

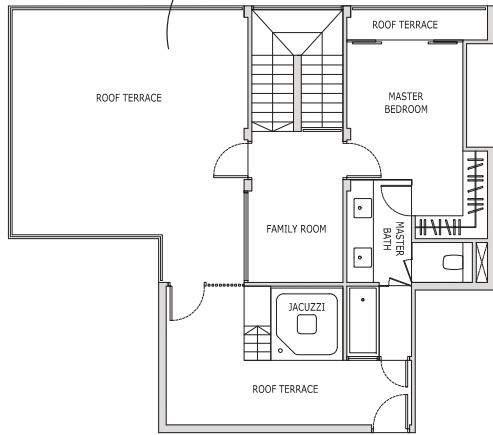

Upper Level

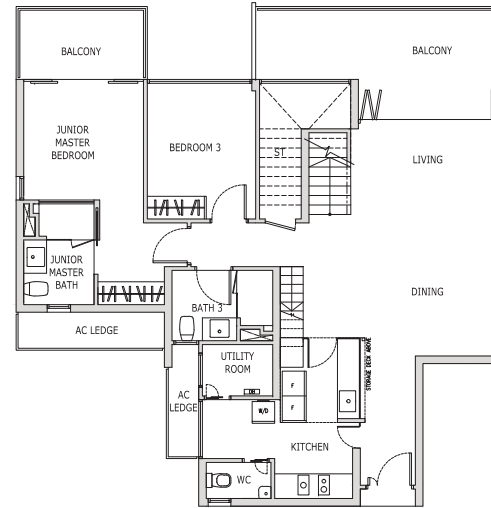

Lower Level

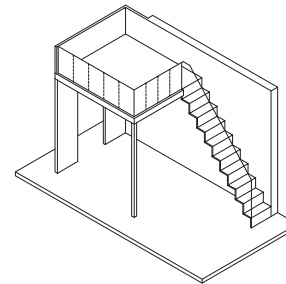

Isometric view of storage deck
 Clear ceiling height of 3.3m

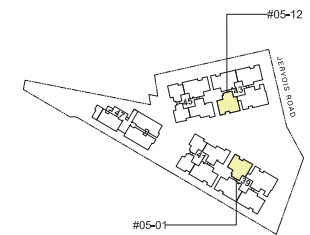

KEY PLAN
 THIS KEY PLAN IS NOT TO SCALE

0 1 3 5M

The above plan is subject to change as may be required or approved by the relevant authorities.
 All floor areas are approximate and subject to final survey.

Penthouse

Type PH2
 248 sqm / 2,669 sqft
 Blk 43 #05-15
 (Mirrored)
 Blk 39 #05-03

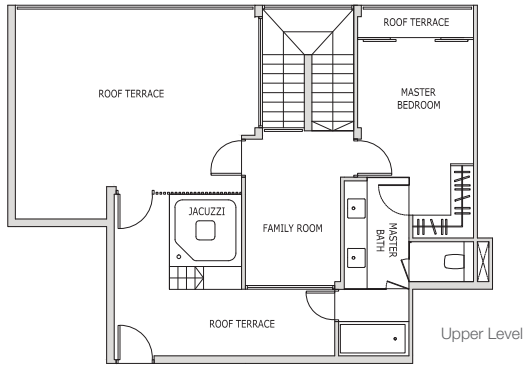

Upper Level

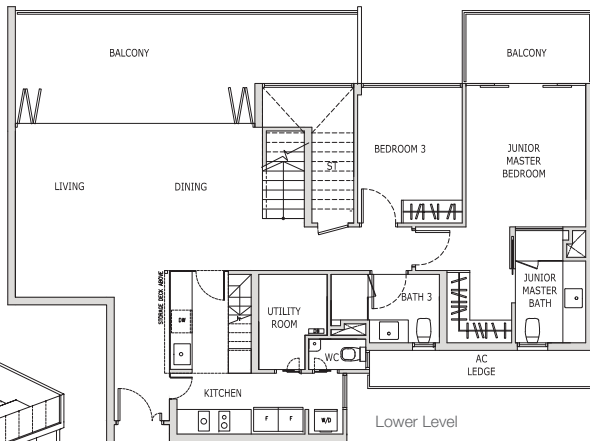

Lower Level

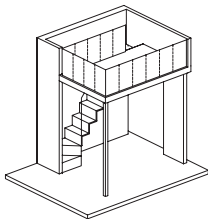

Isometric view of storage deck
 Clear ceiling height of 3.3m



KEY PLAN
 THIS KEY PLAN IS NOT TO SCALE

The above plan is subject to change as may be required or approved by the relevant authorities.
 All floor areas are approximate and subject to final survey.

Penthouse

Type PH3
 137 sqm / 1,475 sqft
 (Includes 6 sqm / 65 sqft strata void)
 Blk 41 #05-07
 Blk 45 #05-20
 (Mirrored)
 Blk 41 #05-06
 Blk 45 #05-19

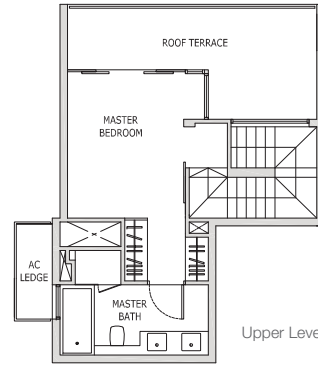

Upper Level

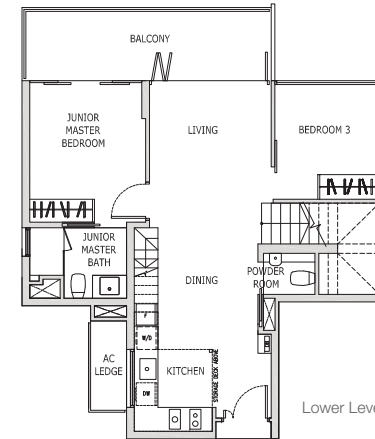

Lower Level

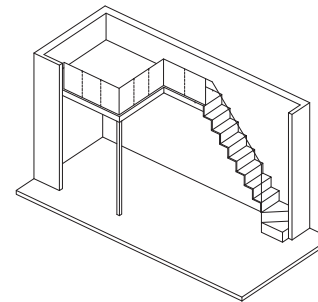

Isometric view of storage deck
 Clear ceiling height of 3.3m

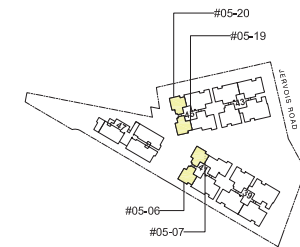

KEY PLAN
 THIS KEY PLAN IS NOT TO SCALE

The above plan is subject to change as may be required or approved by the relevant authorities.
 All floor areas are approximate and subject to final survey.

Penthouse

Type PH4
 279 sqm / 3,003 sqft
 Blk 39 #05-02
 (Mirrored)
 Blk 43 #05-11

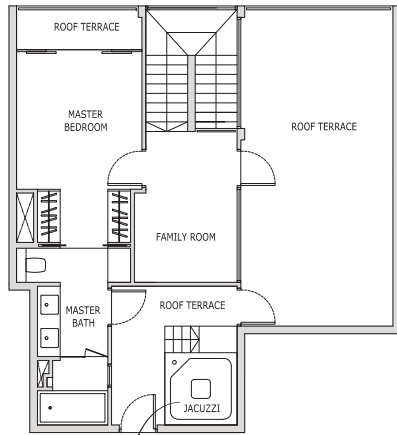

Upper Level

*Evening indulgence - slipping bubbly
 in my bubble bath.*

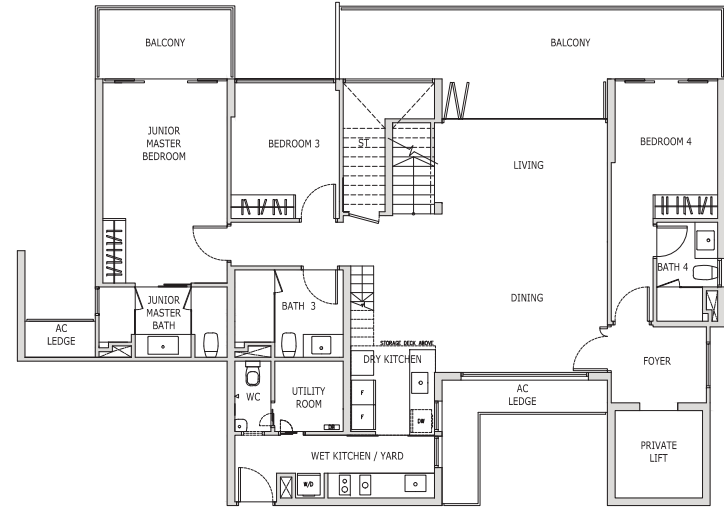

Lower Level

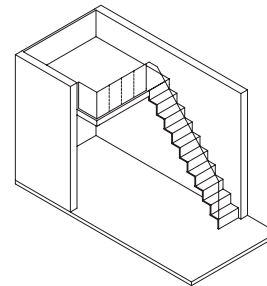

Isometric view of storage deck
 Clear ceiling height of 3.3m



The above plan is subject to change as may be required or approved by the relevant authorities.
 All floor areas are approximate and subject to final survey.

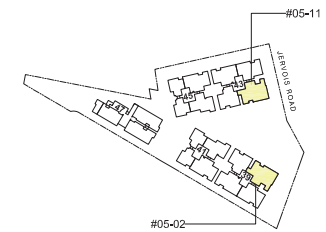

KEY PLAN
 THIS KEY PLAN IS NOT TO SCALE

Penthouse

Type PH5
 264 sqm / 2,842 sqft
 Blk 41 #05-09
 Blk 43 #05-14
 (Mirrored)
 Blk 39 #05-04
 Blk 45 #05-16

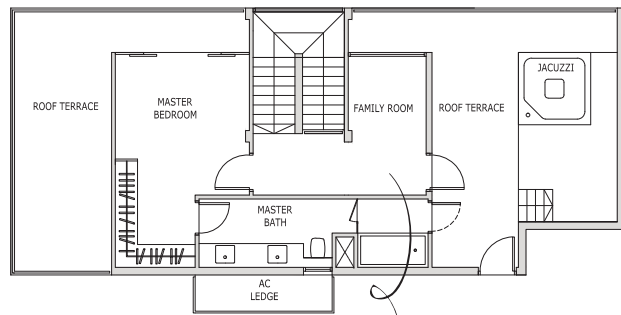

Put extra pleasure with my Martin Bellone

Upper Level

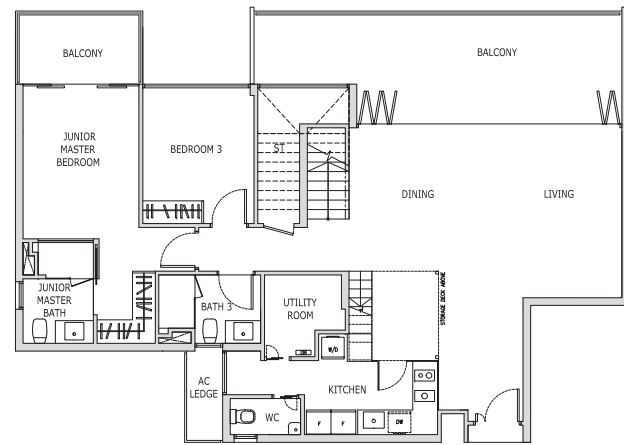

Lower Level

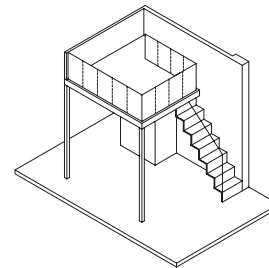

Isometric view of storage deck
 Clear ceiling height of 3.3m



The above plan is subject to change as may be required or approved by the relevant authorities.
 All floor areas are approximate and subject to final survey.

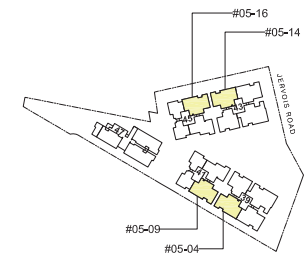

KEY PLAN
 THIS KEY PLAN IS NOT TO SCALE

Penthouse

Type PH6
 220 sqm / 2,368 sqft
 Blk 41 #05-08
 (Mirrored)
 Blk 45 #05-18

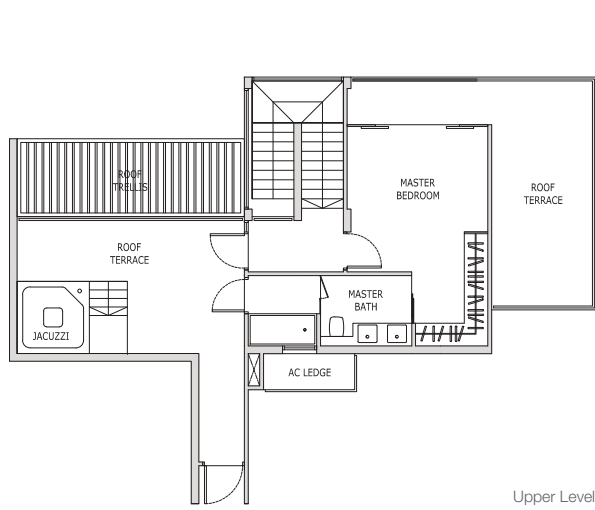

Upper Level

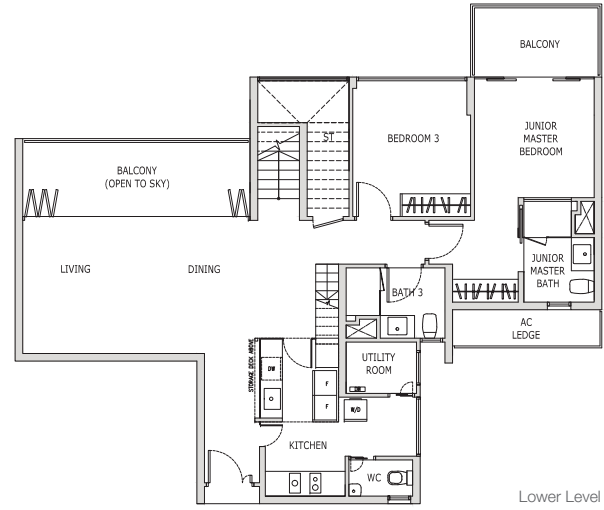

Lower Level

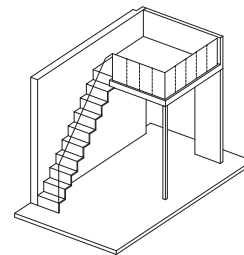

Isometric view of storage deck
 Clear ceiling height of 3.3m

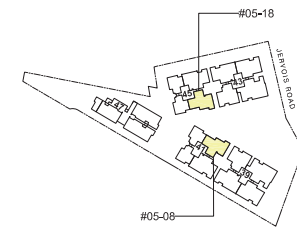

The above plan is subject to change as may be required or approved by the relevant authorities.
 All floor areas are approximate and subject to final survey.

KEY PLAN
 THIS KEY PLAN IS NOT TO SCALE

Penthouse

Type PH7A
 216 sqm / 2,325 sqft
 Blk 47 #05-21
 (Mirrored)
 Blk 47 #05-23

Penthouse

Type PH7B
 187 sqm / 2,013 sqft
 Blk 47 #05-25

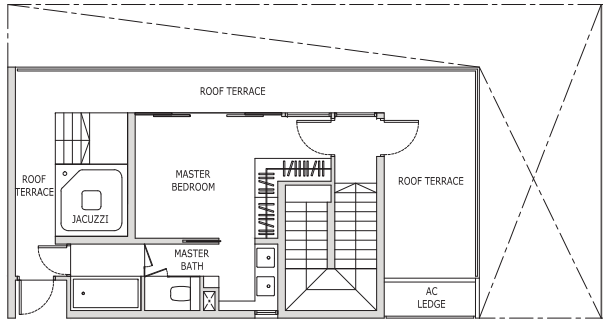

Upper Level

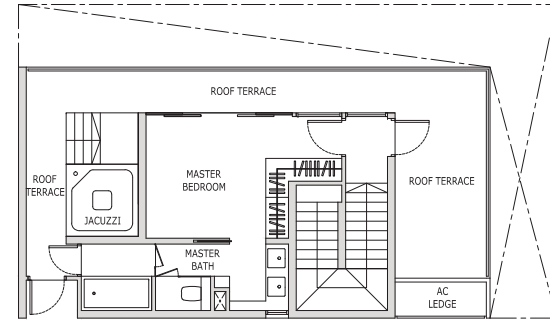

Upper Level

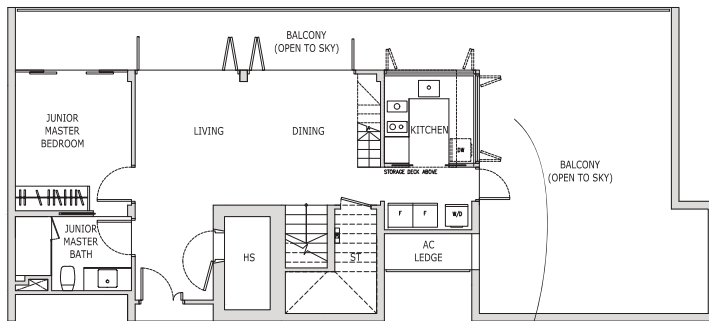

Lower Level

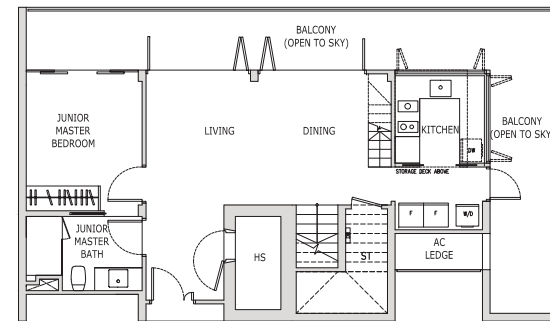

Lower Level

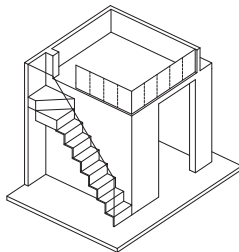

Isometric view of storage deck
 Clear ceiling height of 3.2m

0 1 3 5M

*The perfect breakfast nook
 on a lazy Sunday*

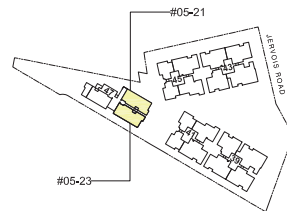

KEY PLAN
 THIS KEY PLAN IS NOT TO SCALE

The above plan is subject to change as may be required or approved by the relevant authorities.
 All floor areas are approximate and subject to final survey.

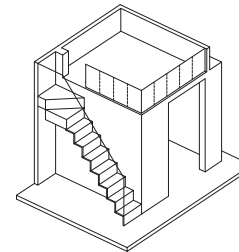

Isometric view of storage deck
 Clear ceiling height of 3.2m

0 1 3 5M

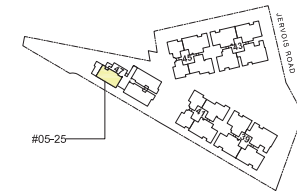

KEY PLAN
 THIS KEY PLAN IS NOT TO SCALE

The above plan is subject to change as may be required or approved by the relevant authorities.
 All floor areas are approximate and subject to final survey.